

**ELKO EP, s.r.o.**  
 Palackého 493  
 769 01 Holešov, Vsetuly  
 Czech Republic  
 Tel.: +420 573 514 211  
 e-mail: elko@elkoep.com  
 www.elkoep.com

Made in Czech Republic

02-173/2022 Rev.: 0



## CRM-9S

### Multifunction time relay - solid state output



#### Characteristic

- Multifunction time relay for universal use in automation, control and regulation or in house installations
- Universal supply voltage AC/DC 12 – 240 V
- Noiseless switching output
- Comfortable and well-arranged function and time-range setting by rotary switches.
- Time scale 0.1 s - 10 days divided into 10 ranges:  
 (0.1 s - 1 s / 1 s - 10 s / 0.1 min - 1 min / 1 min - 10 min / 0.1 hrs - 1 h / 1 h - 10 hrs / 0.1 day - 1 day / 1 day - 10 days / only ON / only OFF)
- Output contact: 1x static contactless output (triac) 1.5 A, switches potential A1
- Multifunction red LED flashes or shines depending on the operating states

#### Description

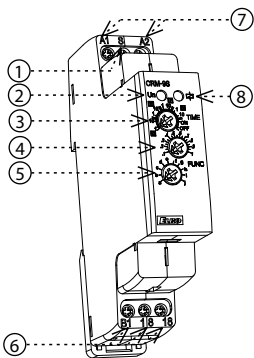

1. Control input (S)
2. Supply voltage indication
3. Time range setting
4. Fine time setting
5. Function setting
6. Output contact (B1-18-18)
7. Supply voltage terminals
8. Indication of operating states

#### Symbol

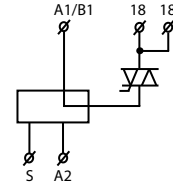

#### Connection

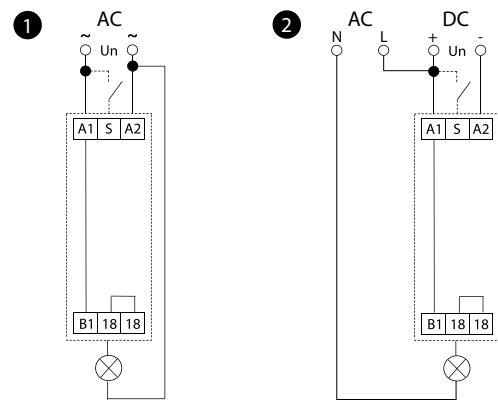

#### Possibility to connect load onto controlling input:

It is possible to connect the load (e.g.: contactor) between terminals S-A2, without any interruption of correct relay function.

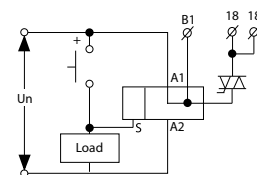

## Technical parameters

### CRM-9S

#### Power supply

Supply terminals:	A1-A2
Supply voltage*:	AC/DC 12 – 240 V (AC 50-60 Hz)
Consumption (max.):	3 VA/0.7 W
Supply voltage tolerance:	-15 %; +10 %

#### Time circuit

Number of functions:	10
Time ranges:	0.1 s – 10 days
Time setting:	rotary switch and potentiometer
Time deviation:	5 % – mechanical setting
Repeat accuracy:	0.2 % – set value stability
Temperature coefficient:	0.01 %/°C, at = 20 °C (0.01 %/°F, at = 68 °F)

#### Output

Contact type:	1× static contactless output (triac)
Current rating:	1.5 A/AC1
Breaking capacity:	375 VA/AC1
Inrush current:	60 A/< 10 ms
Switching voltage:	250 V AC
Power dissipation (max.):	1.4 W
Voltage drop across switch:	max. 0.9 V/lmax.
Load to terminal B1:	Yes/lmax. 1.5 A
Electrical lifetime (AC1):	100.000.000 ops.

#### Control

Control terminals:	A1-S
Load between S-A2:	Yes
Impulse length:	min. 25 ms/max. unlimited
Reset time:	max. 150 ms

#### Other information

Operating temperature:	-20 °C .. +55 °C
Storage temperature:	-30 °C .. +70 °C
Operating position:	any
Mounting:	DIN rail EN 60715
Protection degree:	IP40 front panel/IP20 terminals
Overvoltage category:	III.
Pollution degree:	2
Cross-wire section – solid/ stranded with ferrule (mm <sup>2</sup> ):	max. 1× 2.5, 2× 1.5/ max. 1× 2.5 (AWG 12)
Dimensions:	90 × 17.6 × 64 mm (3.5" × 0.7" × 2.5")
Weight:	55 g (1.95 oz)
Standards:	EN 61812-1

\* Load can only be connected to AC voltage, see connection diagram 2.

## Warning

Device is constructed for connection in 1-phase network AC/DC 12 – 240 V and must be installed in accordance with regulations and standards applicable in the country of use. Installation, connection, setting and servicing should be installed by qualified electrician staff only, who has learnt these instruction and functions of the device. This device contains protection against overvoltage peaks and disturbances in supply. For correct function of the protection of this device there must be suitable protections of higher degree (A,B,C) installed in front of them. According to standards elimination of disturbances must be ensured. Before installation the main switch must be in position "OFF" and the device should be de-energized. Don't install the device to sources of excessive electro-magnetic interference. By correct installation ensure ideal air circulation so in case of permanent operation and higher ambient temperature the maximal operating temperature of the device is not exceeded. For installation and setting use screw-driver cca 2 mm. The device is fully-electronic - installation should be carried out according to this fact. Non-problematic function depends also on the way of transportation, storing and handling. In case of any signs of destruction, deformation, non-function or missing part, don't install and claim at your seller it is possible to dismount the device after its lifetime, recycle, or store in protective dump.

## Functions



### ON DELAY

When the input voltage U is applied, timing delay t begins. Relay contacts R change state after time delay is complete. Contacts R return to their shelf state when input voltage U is removed. Trigger switch is not used in this function.

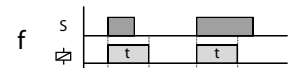

### SINGLE SHOT

Upon application of input voltage U, the relay is ready to accept trigger signal S. Upon application of the trigger signal S, the relay contacts R transfer and the preset time t begins. During time-out, the trigger signal S is ignored. The relay resets by applying the trigger switch S when the relay is not energized.

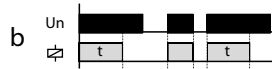

### INTERVAL ON

When input voltage U is applied, relay contacts R change state immediately and timing cycle begins. When time delay is complete, contacts return to shelf state. When input voltage U is removed, contacts will also return to their shelfstate. Trigger switch is not used in this function.



### SINGLE SHOT falling edge

Upon application of input voltage U, the relay is ready to accept trigger signal S. Upon application of the trigger signal S, the relay contacts R transfer and the preset time t begins. At the end of the preset time t, the relay contacts R return to their normal condition unless the trigger switch S is opened and closed prior to time out t (before preset time elapses). Continuous cycling of the trigger switch S at a rate faster than the preset time will cause the relay contacts R to remain closed. If input voltage U is removed, relay contacts R return to their shelf state.



### FLASHER - OFF first

When input voltage U is applied, time delay t begins. When time delay t is complete, relay contacts R change state for time delay t. This cycle will repeat until input voltage U is removed. Trigger switch is not used in this function.

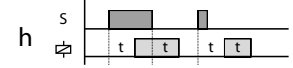

### ON/OFF DELAY

Input voltage U must be applied continuously. When trigger switch S is closed, time delay t begins. When time delay t is complete, relay contacts R change state and remain transferred until trigger switch S is opened. If input voltage U is removed, relay contacts R return to their shelf state.



### FLASHER - ON first

When input voltage U is applied, relay contacts R change state immediately and time delay t begins. When time delay t is complete, contacts return to their shelf state for time delay t. This cycle will repeat until input voltage U is removed. Trigger switch is not used in this function.

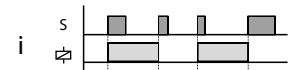

### MEMORY LATCH

Input voltage U must be applied continuously. Output changes state with every trigger switch S closure. If input voltage U is removed, relay contacts R return to their shelf state.

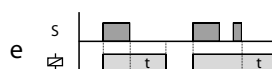

### OFF DELAY

Input voltage U must be applied continuously. When trigger switch S is closed, relay contacts R change state. When trigger switch S is opened, delay t begins. When delay t is complete, contacts R return to their shelf state. If trigger switch S is closed before time delay t is complete, then time is reset. When trigger switch S is opened, the delay begins again, and relay contacts R remain in their energized state. If input voltage U is removed, relay contacts R return to their shelf state.



### PULSE GENERATOR

Upon application of input voltage U, a single output pulse of 0.5 seconds is delivered to relay after time delay t. Power must be removed and reapplied to repeat pulse. Trigger switch is not used in this function.